

EXHIBIT B:
Envelope Examples for
IFB No. 25002



Employees' Retirement System

of the State of Hawaii

*City Financial Tower
201 Merchant Street, Ste. 1400
Honolulu, HI 96813-2980*

#A



AFTER TEN DAYS, RETURN TO
STATE OF HAWAII
DEPARTMENT OF BUDGET AND FINANCE
P.O. BOX 150
HONOLULU, HAWAII 96810-0150

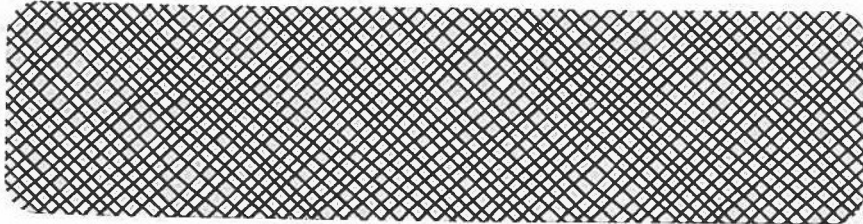

#A

STATE OF HAWAII
DEPARTMENT OF ACCOUNTING
AND GENERAL SERVICES
P.O. BOX 119
HONOLULU, HAWAII 96810-0119

A

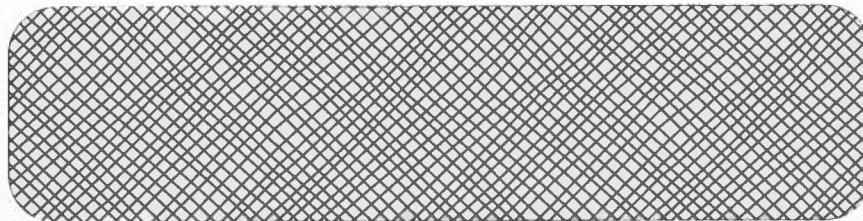

STATE OF HAWAII
DEPARTMENT OF ACCOUNTING
AND GENERAL SERVICES
P.O. BOX 119
HONOLULU, HAWAII 96810-0119

B

STATE OF HAWAII
DEPARTMENT OF ACCOUNTING AND GENERAL SERVICES
AUTOMOTIVE MANAGEMENT DIVISION
P.O. BOX 119
HONOLULU, HAWAII 96810-0119

#A

**STATE OF HAWAII
DEPARTMENT OF ACCOUNTING
AND GENERAL SERVICES
ADMINISTRATIVE SERVICES OFFICE
P.O. BOX 119
HONOLULU, HAWAII 96810-0119**

**STATE OF HAWAII
DEPARTMENT OF ACCOUNTING
AND GENERAL SERVICES
P.O. BOX 119
HONOLULU, HAWAII 96810-0119**

#B

STATE OF HAWAII
DEPARTMENT OF ACCOUNTING AND GENERAL SERVICES
DIVISION OF PUBLIC WORKS
P.O. BOX 119
HONOLULU, HAWAII 96810

#A

#A



STATE OF HAWAII
DEPARTMENT OF CORRECTIONS AND REHABILITATION
1177 ALAKEA STREET
HONOLULU, HAWAII 96813

#B

AFTER 10 DAYS RETURN TO

Crime Victim Compensation Commission

1164 BISHOP ST STE 1530

HONOLULU, HI 96813

ADDRESS CORRECTION REQUESTED

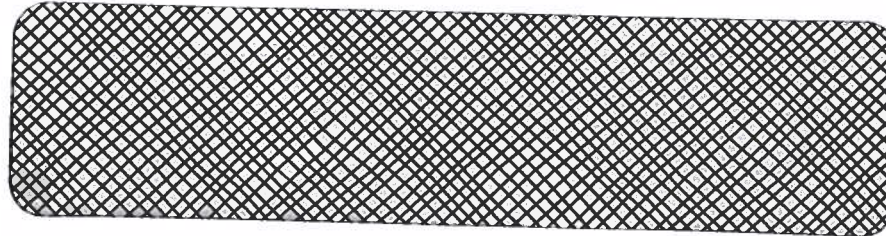



Dept. of Corrections & Rehabilitation
Fiscal Office
1177 Alakea Street. Rm 301
Honolulu, HI 96813

#A

Dept. of Corrections & Rehabilitation
Fiscal Office
1177 Alakea Street. Rm 301
Honolulu, HI 96813

RETURN SERVICE REQUESTED

#B

STATE OF HAWAII
DEPARTMENT OF HAWAIIAN HOME LANDS
P.O. BOX 1721
HONOLULU, HAWAII 96806

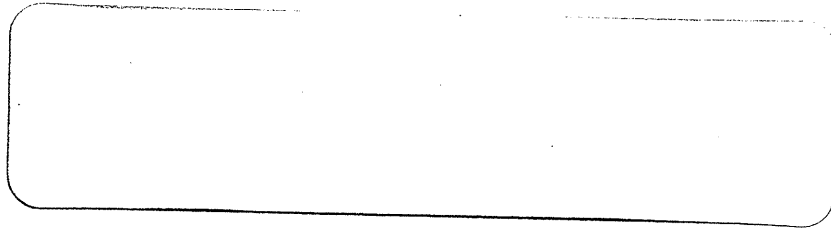

#A

Sample

(01/15/25, 01/15/26, 01/15/27)
12,000 = JAN Delivery
12,000 = JUNE Delivery
(06/16/25, 06/15/26, 06/15/27)

(back of envelope)



Important Notice from DHS, Please Read.
Importante nga Paka-ammo ti DHS, Panga-asiyo ta basaenyo.
Auchean esinesin seni DHS kose mochen aneani.
Kojela Aurok jen DHS, Jouij im Riiti.
DHS (후생국) 에서의 중요한 공지 사항, 꼭 읽으세요.
請閱讀, DHS 重要通知。
Thông Báo Quan Trọng từ DHS, Xin Vui Lòng Đọc.

 Made from Recycled Paper

DHS-APPEALS OFFICE
P.O. BOX 339
HONOLULU, HAWAII 96809-0339

Return Service Requested

#A

(front of envelope)

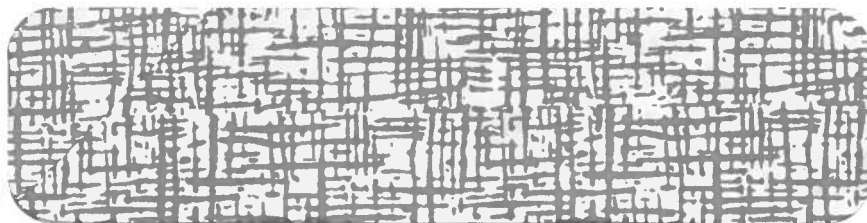

DEPARTMENT OF HUMAN SERVICES
Audit, Quality Control, and Research Office/QC-Hilo
75 Aupuni Street, Room 111
Hilo, Hawaii 96720

Return Service Requested

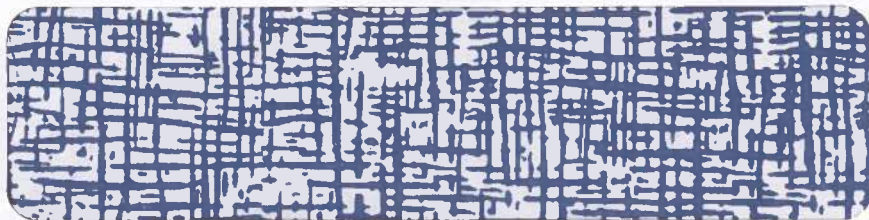

#A

DEPARTMENT OF HUMAN SERVICES
Audit, Quality Control, and Research Office/QC-Maui
54 High Street, Room 125
Wailuku, Hawaii 96793

Return Service Requested

#A

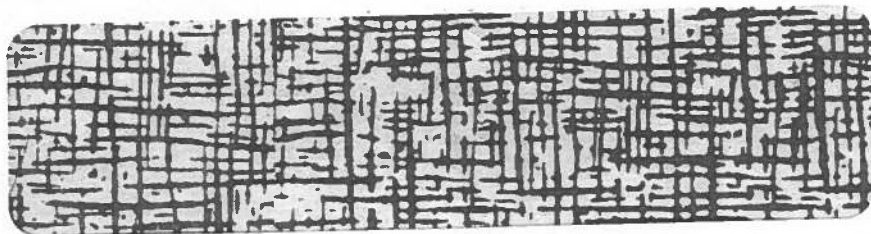

DEPARTMENT OF HUMAN SERVICES
Audit, Quality Control, and Research Office/QC
P.O. Box 339
Honolulu, Hawaii 96809-0339

Return Service Requested

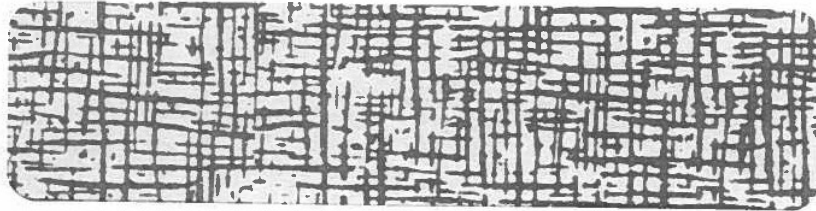

#A



HAWAII PUBLIC HOUSING AUTHORITY
AMP 30 MANAGEMENT OFFICE
99-132 KOHOMUA ST
AIEA, HI 96701

#A

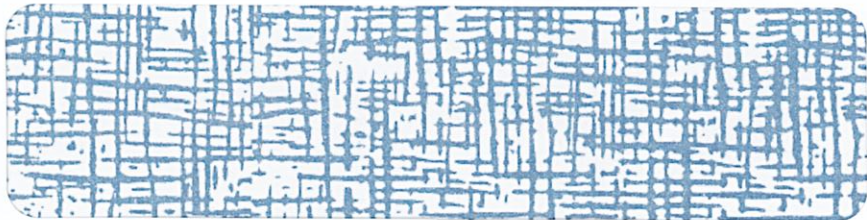



HAWAII PUBLIC HOUSING AUTHORITY

AMP 31
1002 N.SCHOOL STREET
P.O. BOX 17907
HONOLULU, HAWAII 96817

#A





HAWAII PUBLIC HOUSING AUTHORITY

1002 N. SCHOOL STREET
P.O. BOX 17907
HONOLULU, HAWAII 96817

#A

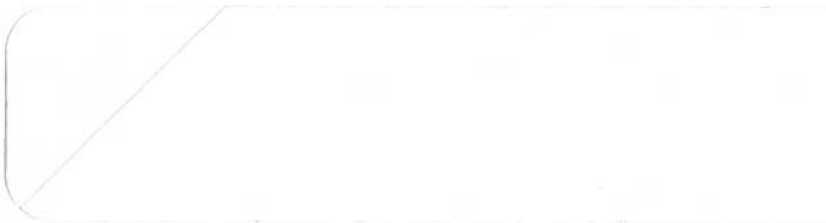



HAWAII PUBLIC HOUSING AUTHORITY

1002 N. SCHOOL STREET
P.O. BOX 17907
HONOLULU, HAWAII 96817

#A

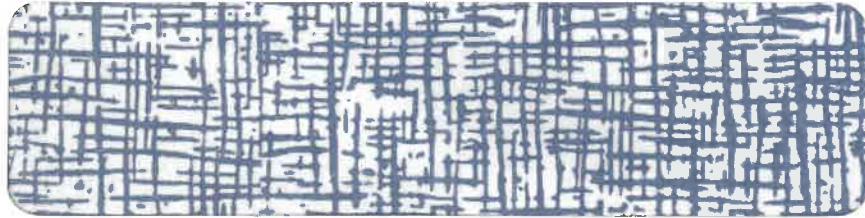

#A



HAWAII PUBLIC HOUSING AUTHORITY
KALANIHUIA – OFFICE
1220 AALA STREET
HONOLULU, HI 96817



HAWAII PUBLIC HOUSING AUTHORITY
600 WAILOA STREET
HILO, HAWAII 96720

#A

RETURN SERVICE REQUESTED

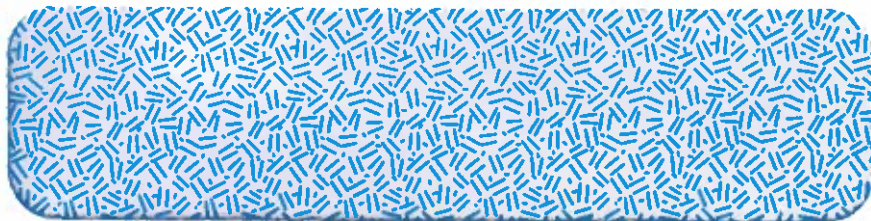

Hawaii Public Housing Authority
4726 Malu Road
Kapaa, HI 96746

#A

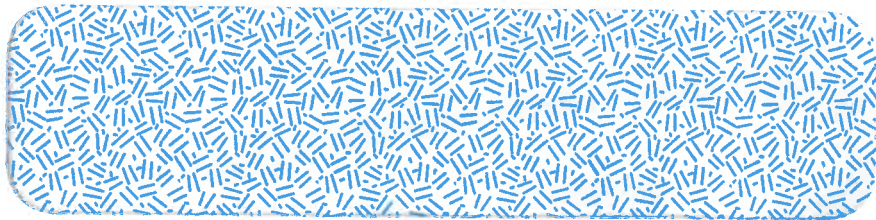



HAWAII PUBLIC HOUSING AUTHORITY

1002 N. SCHOOL STREET
P.O. BOX 17907
HONOLULU, HAWAII 96817

#A

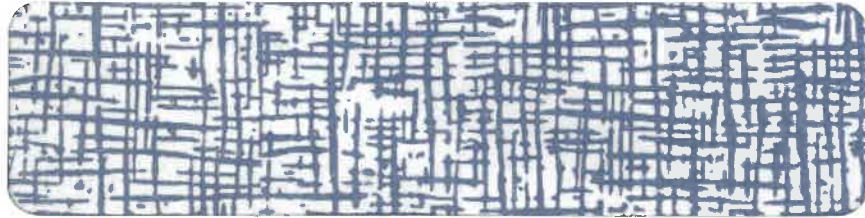

#A



HAWAII PUBLIC HOUSING AUTHORITY
1002 N. SCHOOL STREET
P.O. BOX 17907
HONOLULU, HAWAII 96817

#A



HAWAII PUBLIC HOUSING AUTHORITY
1002 N. SCHOOL STREET
P.O. BOX 17907
HONOLULU, HAWAII 96817

#A

State of Hawaii
Hawaii Public Housing Authority
Kauhale Nani
310 N. Cane St, Management Office
Wahiawa, HI 96786



					40
	\$1,296	\$1,703	\$2,197	\$2,485	
				\$3,693	40

#A



HAWAII PUBLIC HOUSING AUTHORITY
1002 NORTH SCHOOL STREET *AKUP 50*
P.O. BOX 17907
HONOLULU, HAWAII 96817



#A



HAWAII PUBLIC HOUSING AUTHORITY

COMPLIANCE OFFICE
1002 N. SCHOOL STREET
P.O. BOX 17907
HONOLULU, HAWAII 96817

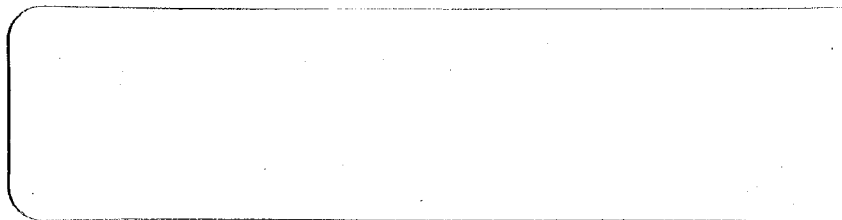

#A



HAWAII PUBLIC HOUSING AUTHORITY

Contract & Procurement Office

1002 NORTH SCHOOL STREET

P.O. BOX 17907

HONOLULU, HAWAII 96817

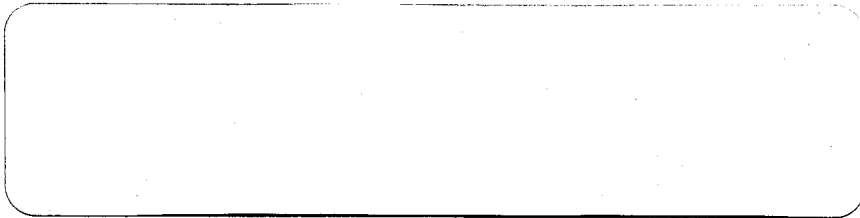



HAWAII PUBLIC HOUSING AUTHORITY
FISCAL MANAGEMENT OFFICE
1002 N. SCHOOL STREET
P.O. BOX 17907
HONOLULU, HAWAII 96817

#A

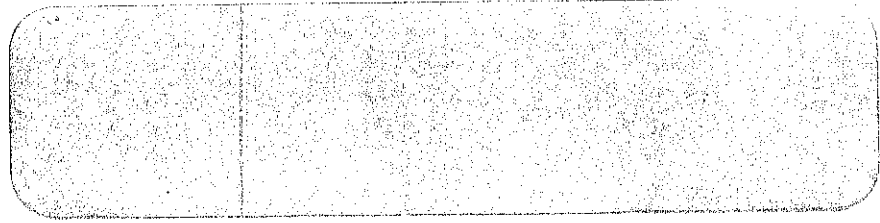



HAWAII PUBLIC HOUSING AUTHORITY
1002 N. SCHOOL STREET
P.O. BOX 17907
HONOLULU, HAWAII 96817

#A

STATE OF HAWAII
HAWAII PUBLIC HOUSING AUTHORITY
Kamalu-Ho'olulu Elderly, MU42
94-941 Kaulu Place, Office #A107
Waipahu, Hawaii 96797
Phone: (808) 675-0099
Fax: (808) 675-0098

#A

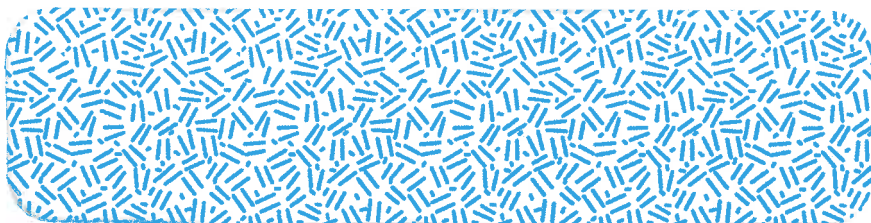

Department of Human Services
Med-QUEST Division
Health Care Services Branch
601 Kamokila Boulevard, Room 506A
Kapolei, Hawaii 96707

#1

#A

STATE OF HAWAII
DEPARTMENT OF HUMAN SERVICES
MED-QUEST DIVISION – HCWIP
P.O. BOX 700190
Kapolei, Hawaii 96709-0190



Sample: Department of Law Enforcement, Administrative Services Office

Item #B Envelope front

Font = Arial 11

Return address should be same as below:

Department of Law Enforcement

715 S. King Street, Suite 502

Honolulu, HI 96813

#B

Department of Law Enforcement
715 S. King Street, Suite 502
Honolulu, HI 96813

Sample: Department of Law Enforcement, Administrative Services Office

Item #B Envelope back

#B

The image shows the back of a yellow envelope. The envelope is rectangular with a curved top flap. The flap is folded down, and the back of the envelope is visible. The paper has a slightly textured appearance. The envelope is centered on a light blue background.

STATE OF HAWAII
DEPARTMENT OF LABOR & INDUSTRIAL RELATIONS
BOILER AND ELEVATOR INSPECTION BRANCH
830 PUNCHBOWL STREET
HONOLULU, HAWAII 96813

#A

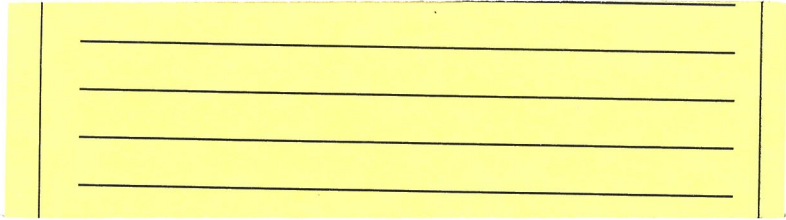

STATE OF HAWAII
DEPARTMENT OF LAND AND NATURAL RESOURCES
BUREAU OF CONVEYANCES
P.O. BOX 2867
HONOLULU, HAWAII 96803

#A



STATE OF HAWAII
DEPARTMENT OF LAND AND NATURAL RESOURCES
DIVISION OF BOATING AND OCEAN RECREATION
HONOKOHAU SMALL BOAT HARBOR
74-380 KEALAKEHE PARKWAY
KAILUA-KONA, HAWAII 96740-2704

#A

RETURN SERVICE REQUESTED

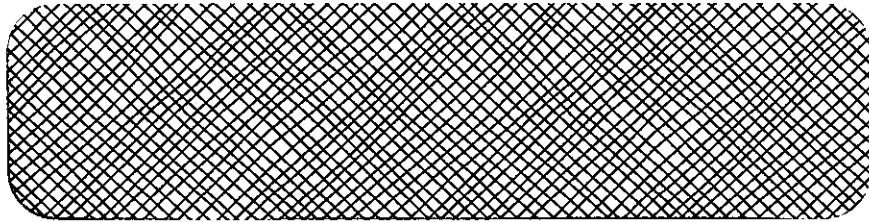

#A

AFTER 10 DAYS, RETURN TO
DEPARTMENT OF LAND AND NATURAL RESOURCES
LAND DIVISION
130 MAHALANI STREET
WAILUKU, MAUI, HAWAII 96793



#A

AFTER 10 DAYS, RETURN TO
DEPARTMENT OF LAND AND NATURAL RESOURCES
LAND DIVISION
P.O. BOX 621
HONOLULU, HAWAII 96809



#B

STATE OF HAWAII
DEPARTMENT OF TRANSPORTATION
AIRPORTS
400 RODGERS BOULEVARD, SUITE 700
HONOLULU, HAWAII 96819-1880

RETURN SERVICE REQUESTED



STATE OF HAWAII
DEPARTMENT OF TAXATION
P.O. BOX 259
HONOLULU, HI 96809-0259

#A

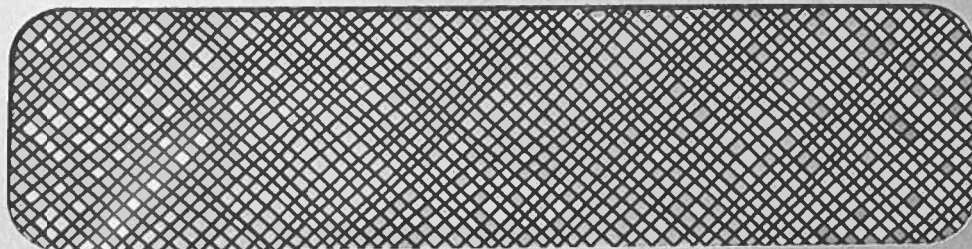

**FIELD AUDIT BRANCH
STATE OF HAWAII
DEPARTMENT OF TAXATION
P.O. BOX 259
HONOLULU, HI 96809-0259**

#A

ADDRESS SERVICE REQUESTED

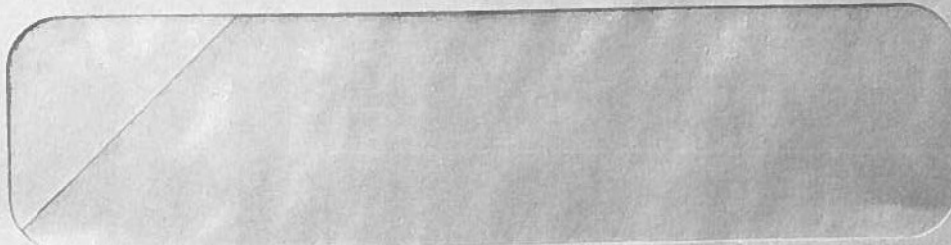

State of Hawaii
Department of Taxation
P.O. Box 259
Honolulu, HI 96809-0259

#A

SPECIAL ENFORCEMENT SECTION

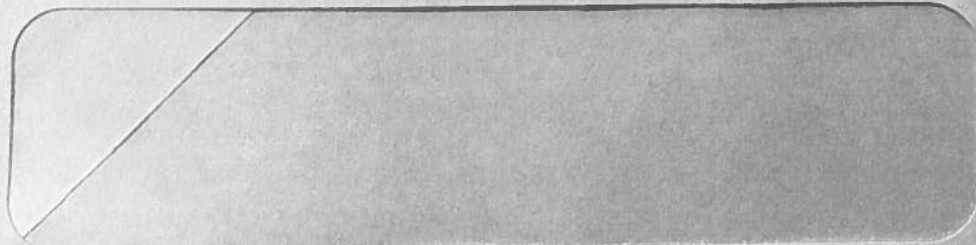

#A

A - DoTax - Compliance Hawaii District Office - Hilo

STATE OF HAWAII
DEPARTMENT OF TAXATION
HAWAII DISTRICT OFFICE
75 AUPUNI STREET, ROOM 101
HILO, HAWAII 96720-4245

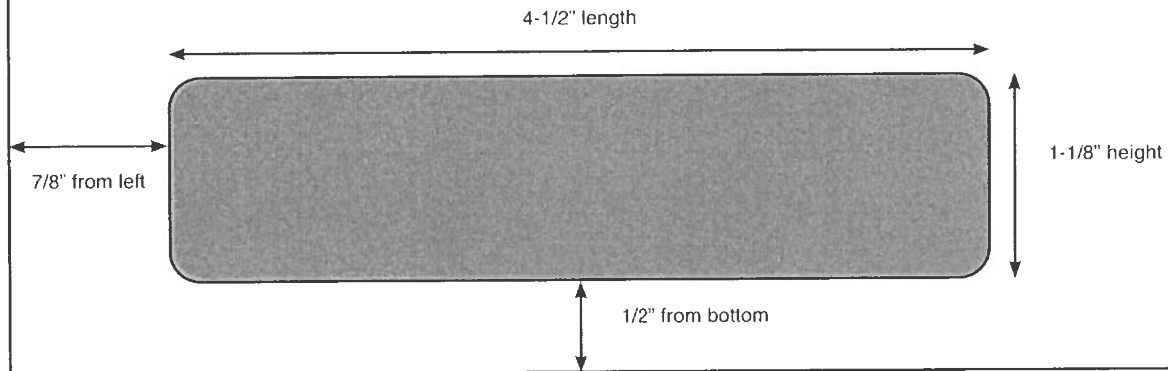

Office Audit Branch
State of Hawaii
Department of Taxation
P.O. Box 259
Honolulu, HI 96809-0259

#A

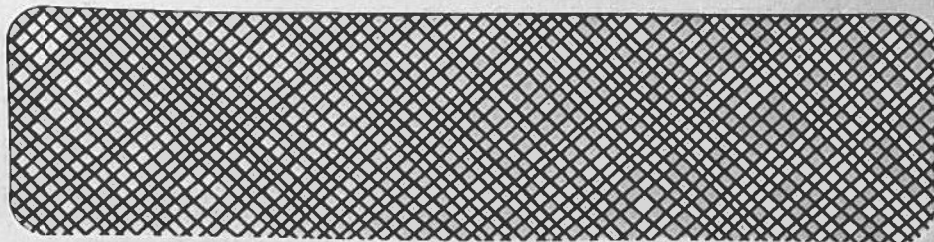

#A

A - DoTax - Taxpayer Services & Processing/Document Processing - Blase

STATE OF HAWAII
DEPARTMENT OF TAXATION
P.O. BOX 259
HONOLULU, HI 96809-0259

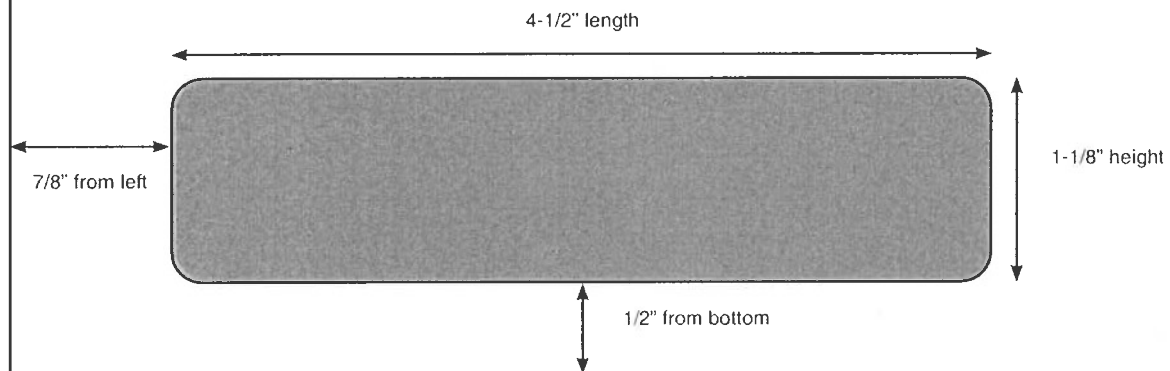

#1

STATE OF HAWAII
DEPARTMENT OF TRANSPORTATION
HARBORS DIVISION - KAUAI DISTRICT
3242 WAAPA ROAD
LIHUE, HAWAII 96766

RETURN SERVICE REQUESTED

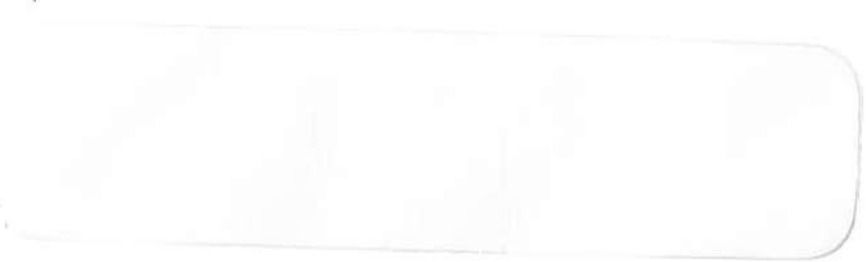

#1

State of Hawaii
Department of Transportation, Harbors
79 S. Nimitz Highway
Honolulu, Hawaii 96813-4898
RETURN SERVICE REQUESTED



Return Address - Envelope 10 top left corner

State of Hawaii
Department of Transportation, Harbors
79 S. Nimitz Highway
Honolulu, Hawaii 96813-4898
RETURN SERVICE REQUESTED

- 1) Times New Roman 10
- 2) Times New Roman 11 Bold
- 3) Times New Roman 10
- 4) Times New Roman 10
- 5) Space (Times New Roman 6)
- 6) Arial 8
- 7) Font Color: Navy

#A

STATE OF HAWAII
DEPARTMENT OF TRANSPORTATION
HIGHWAYS DIVISION, FISCAL OFFICE
869 PUNCHBOWL STREET, ROOM 201
HONOLULU, HAWAII 96813

RETURN SERVICE REQUESTED

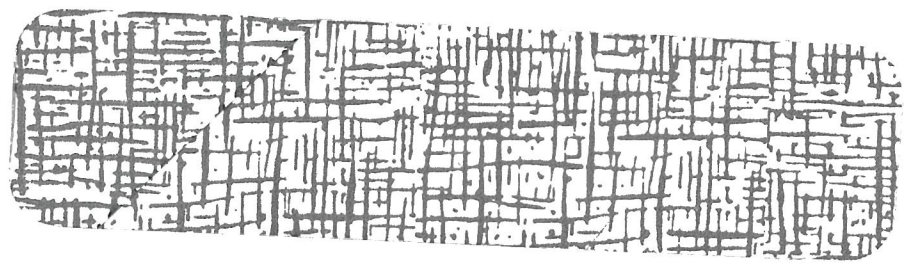

#B

STATE OF HAWAII
DEPARTMENT OF TRANSPORTATION
HIGHWAYS DIVISION, FISCAL OFFICE
869 PUNCHBOWL STREET, ROOM 201
HONOLULU, HAWAII 96813



#E

STATE OF HAWAII
DEPARTMENT OF TRANSPORTATION
HIGHWAYS DIVISION, FISCAL OFFICE
869 PUNCHBOWL STREET, ROOM 201
HONOLULU, HAWAII 96813

RETURN SERVICE REQUESTED

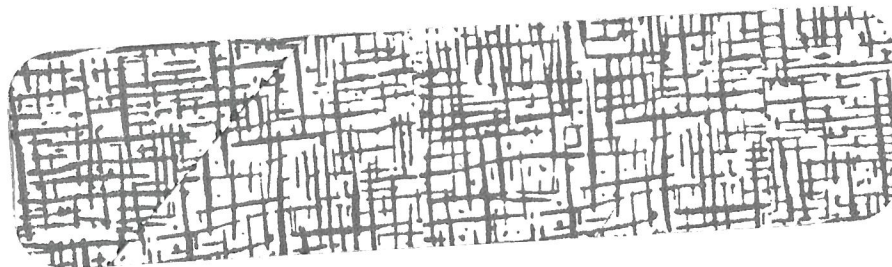

#E



FIFTH JUDICIAL CIRCUIT – FISCAL DIVISION
THE JUDICIARY • STATE OF HAWAII
3970 Kā'ana Street, Suite 205
Lihue, Hawaii'i 96766-1282

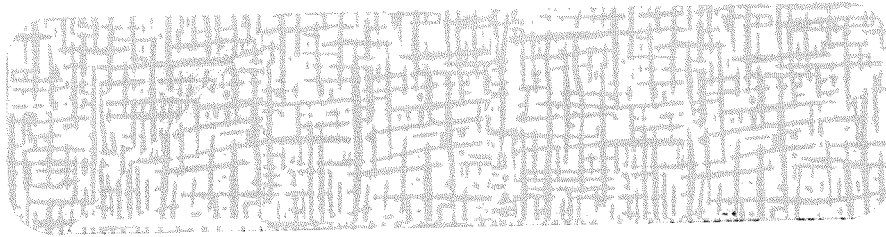

#A



**FAMILY COURT OF THE FIFTH CIRCUIT
JUVENILE CLIENT & FAMILY SERVICES BRANCH**

THE JUDICIARY • STATE OF HAWAII
3970 Kā'ana Street, Suite 305
Līhu'e, Hawaii 96766-1283

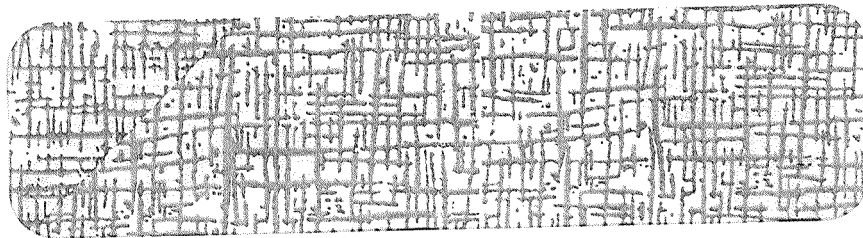

#A



CIRCUIT COURT OF THE FIFTH CIRCUIT

THE JUDICIARY • STATE OF HAWAII

3970 Kā'ana Street, Suite 301

Līhu'e, Hawaii 96766-1283

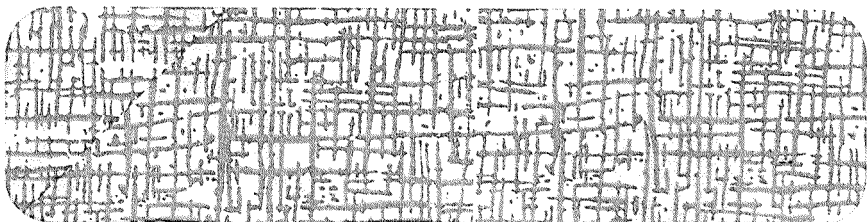

#A



Circuit Court of the Fifth Circuit - Special Services Division

THE JUDICIARY · STATE OF HAWAII

3970 KĀ'ANA STREET Suite 301

LIHU'E, KAUA'I, HAWAII 96766-1282

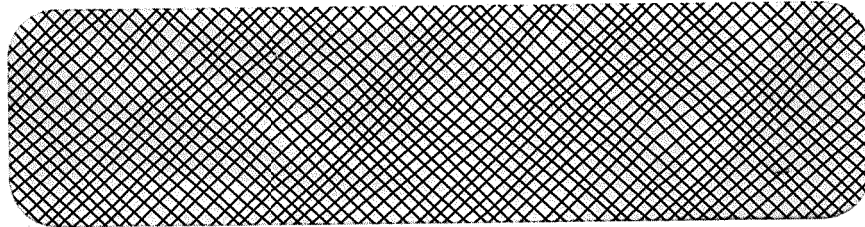

#B

DISTRICT COURT OF THE FIRST CIRCUIT
THE JUDICIARY - STATE OF HAWAII
Fiscal Procurement Section
1111 Alakea Street, 9th Floor
Honolulu, Hawaii 96813-2897

#A



DISTRICT COURT OF THE FIRST CIRCUIT
COURT OPERATIONS • TRAFFIC VIOLATIONS BUREAU
THE JUDICIARY • STATE OF HAWAII
1111 Alakea Street, Second Floor
Honolulu, Hawaii'i 96813-2897

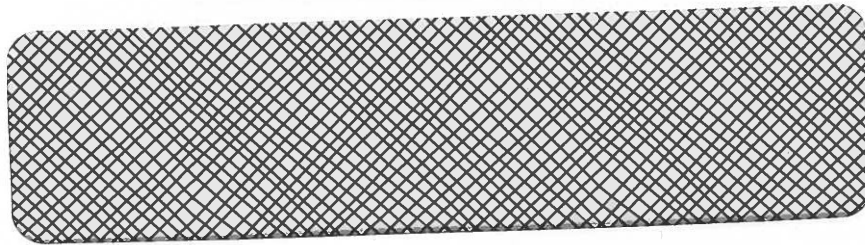

#A



DISTRICT COURT OF THE FIRST CIRCUIT
THE JUDICIARY • STATE OF HAWAII
EWA DISTRICT COURT
870 Fourth Street
Pearl City, Hawaii 96782-3398

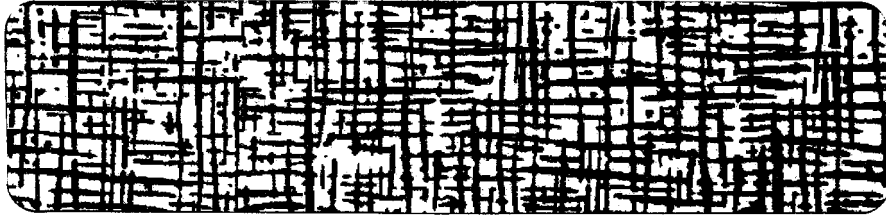



DISTRICT COURT OF THE FIRST CIRCUIT
'EWA-PEARL CITY DIVISION
THE JUDICIARY • STATE OF HAWAII
870 Fourth Street
Pearl City, Hawai'i 96782-3398

#E

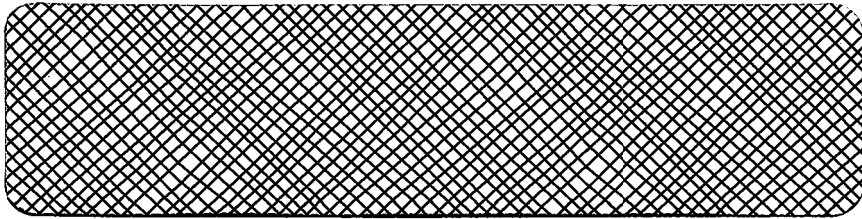

THE JUDICIARY – STATE OF HAWAII
FAMILY COURT OF THE FIRST CIRCUIT
FISCAL OFFICE
4675 KAPOLEI PARKWAY
KAPOLEI, HI 96707

#B

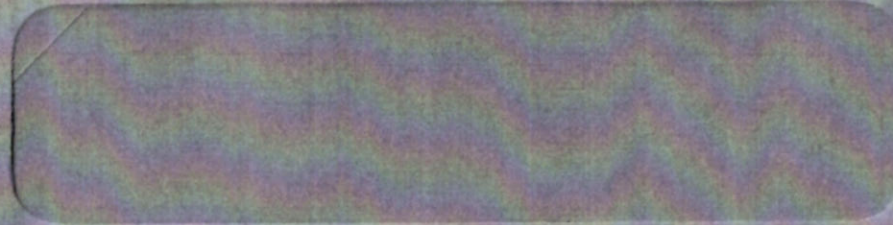

THE JUDICIARY – STATE OF HAWAII
FAMILY COURT OF THE FIRST CIRCUIT
FISCAL OFFICE
4675 KAPOLEI PARKWAY
KAPOLEI, HI 96707

#A





DISTRICT COURT OF THE FIRST CIRCUIT
COURT OPERATIONS • LEGAL DOCUMENTS BRANCH 2
THE JUDICIARY • STATE OF HAWAII
1111 Alakea Street, 3rd Floor
Honolulu, Hawai'i 96813-2897

#A

